

SIDE SENSING DC INDUCTIVE PROXIMITY SWITCH

φ4
●
0.8 mm
stainless steel
●

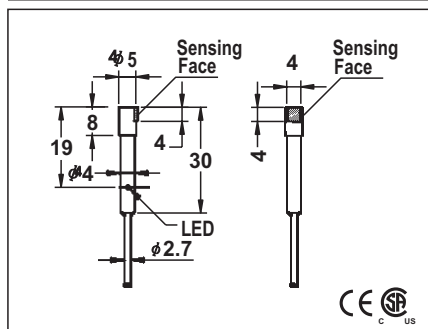

10-30VDC or 5-36V
<10%
<10mA
200mA
<0.01mA
-
-
<1.5V
2KHZ
0.1ms/0.1ms
<15%(Sr)
<1.0%(Sr)
IP67
-25°C - +70°C
<10%(Sr)
YES
220mA
<10ms
RFI>3V/m / EFT>1KV / ESD>4KV (contact)
IEC 60947-5-2, Part 7.4.1 / IEC 60947-5-2, Part 7.4.2
POM

FCU1-D040.8N-A3U2T	1
FCU1-D040.8N-B3U2T	2
FCU1-D040.8P-A3U2T	3
FCU1-D040.8P-B3U2T	4
FCU1-D040.8NUT	21
ICU1-D040.8N-A3U2T	1
ICU1-D040.8N-B3U2T	2
ICU1-D040.8P-A3U2T	3
ICU1-D040.8P-B3U2T	4

NAMUR type specifications see page H-1.

2.7 φ3x0.15
approx.25 g

φ4
●
0.8 mm
stainless steel
●

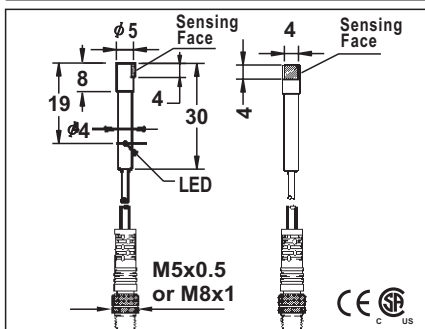

10-30VDC or 5-36V
<10%
<10mA
200mA
<0.01mA
-
-
<1.5V
2KHZ
0.1ms/0.1ms
<15%(Sr)
<1.0%(Sr)
IP67
-25°C - +70°C
<10%(Sr)
YES
220mA
<10ms
RFI>3V/m / EFT>1KV / ESD>4KV (contact)
IEC 60947-5-2, Part 7.4.1 / IEC 60947-5-2, Part 7.4.2
POM

FCU1-D040.8N-A3U0.2T/P5	29	FCU1-D040.8N-A3U0.2T/P8
FCU1-D040.8N-B3U0.2T/P5	30	FCU1-D040.8N-B3U0.2T/P8
FCU1-D040.8P-A3U0.2T/P5	31	FCU1-D040.8P-A3U0.2T/P8
FCU1-D040.8P-B3U0.2T/P5	32	FCU1-D040.8P-B3U0.2T/P8
FCU1-D040.8NUT/P5	21	FCU1-D040.8NUT/P5
ICU1-D040.8N-A3U0.2T/P5	29	ICU1-D040.8N-A3U0.2T/P8
ICU1-D040.8N-B3U0.2T/P5	30	ICU1-D040.8N-B3U0.2T/P8
ICU1-D040.8P-A3U0.2T/P5	31	ICU1-D040.8P-A3U0.2T/P8
ICU1-D040.8P-B3U0.2T/P5	32	ICU1-D040.8P-B3U0.2T/P8

FCU***/P5
 M5 Pigtail mode
 FCU***/P8
 M8 Pigtail mode

2.7 φ3x0.15	
approx.25 g	Approx.26 g

φ4
●
0.8 mm
stainless steel
●

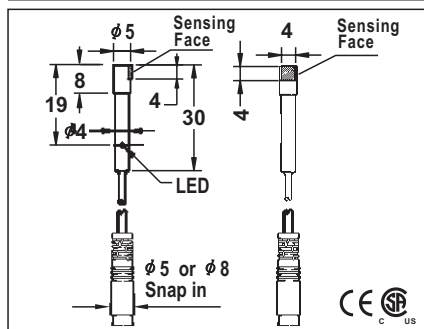

10-30VDC or 5-36V
<10%
<10mA
200mA
<0.01mA
-
-
<1.5V
2KHZ
0.1ms/0.1ms
<15%(Sr)
<1.0%(Sr)
IP67
-25°C - +70°C
<10%(Sr)
YES
220mA
<10ms
RFI>3V/m / EFT>1KV / ESD>4KV (contact)
IEC 60947-5-2, Part 7.4.1 / IEC 60947-5-2, Part 7.4.2
POM

FCU1-D040.8N-A3U0.2T/SN5	29	FCU1-D040.8N-A3U0.2T/SN8
FCU1-D040.8N-B3U0.2T/SN5	30	FCU1-D040.8N-B3U0.2T/SN8
FCU1-D040.8P-A3U0.2T/SN5	31	FCU1-D040.8P-A3U0.2T/SN8
FCU1-D040.8P-B3U0.2T/SN5	32	FCU1-D040.8P-B3U0.2T/SN8
FCU1-D040.8NUT/SN5	21	FCU1-D040.8NUT/SN8
ICU1-D040.8N-A3U0.2T/SN5	29	ICU1-D040.8N-A3U0.2T/SN8
ICU1-D040.8N-B3U0.2T/SN5	30	ICU1-D040.8N-B3U0.2T/SN8
ICU1-D040.8P-A3U0.2T/SN5	31	ICU1-D040.8P-A3U0.2T/SN8
ICU1-D040.8P-B3U0.2T/SN5	32	ICU1-D040.8P-B3U0.2T/SN8

FCU***/SN5
 φ5 Pigtail mode
 FCU***/SN8
 φ8 Pigtail mode

2.7 φ3x0.15	
approx.25 g	Approx.26 g

SIDE SENSING DC INDUCTIVE PROXIMITY SWITCH

φ 6.5	
●	●
1.0mm	1.5mm
stainless steel	
●	

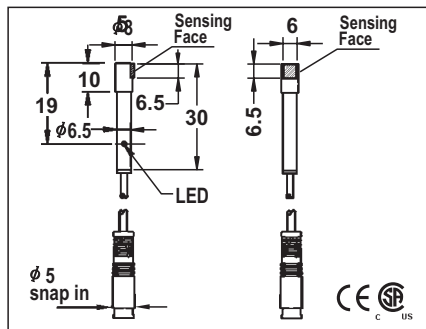

10-30VDC or 5-36VDC
<10%
<10mA
200mA
<0.01mA
-
-
<1.5V(10-30V) or <1.0V(5-36V)
2KHZ
0.1ms/0.1ms
<15%(Sr)
<1.0%(Sr)
IP67
-25°C - +70°C
<10%(Sr)
YES
220mA
<10ms
RFI>3V/m / EFT>1KV / ESD>4KV (contact)
IEC 60947-5-2,Part 7.4.1 / IEC 60947-5-2,Part 7.4.2
POM

FCU1-D0601N-A3U0.2T/SN5	1	
FCU1-D0601N-B3U0.2T/SN5	2	
FCU1-D0601P-A3U0.2T/SN5	3	
FCU1-D0601P-B3U0.2T/SN5	4	
FCU1-D0601N-S4U0.2T/SN5	6	
FCU1-D0601P-S4U0.2T/SN5	5	
FCU1-D0601C-A2U0.2T/SN5	7	FCU1-D061.5C-A2U0.2T/SN5
FCU1-D0601C-B2U0.2T/SN5	8	FCU1-D061.5C-B2U0.2T/SN5
	1	ICU1-D061.5N-A3U0.2T/SN5
	2	ICU1-D061.5N-B3U0.2T/SN5
	3	ICU1-D061.5P-A3U0.2T/SN5
	4	ICU1-D061.5P-B3U0.2T/SN5
	6	ICU1-D061.5P-S4U0.2T/SN5
	5	ICU1-D061.5N-S4U0.2T/SN5

5-36v: ICU*-***** type switching
distance Sn=1.5mm.

3 φ 3x0.15	
Approx.38 g	Approx.39 g

φ 6.5	
●	●
1.0mm	1.5mm
stainless steel	
●	

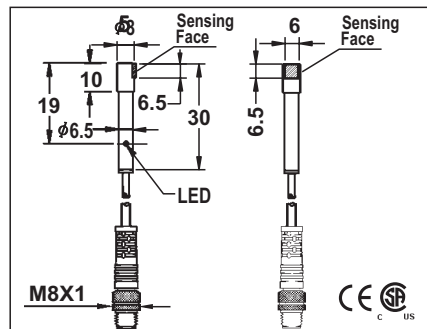

10-30VDC or 5-36VDC
<10%
<10mA
200mA
<0.01mA
-
-
<1.5V(10-30V) or <1.0V(5-36V)
2KHZ
0.1ms/0.1ms
<15%(Sr)
<1.0%(Sr)
IP67
-25°C - +70°C
<10%(Sr)
YES
220mA
<10ms
RFI>3V/m / EFT>1KV / ESD>4KV (contact)
IEC 60947-5-2,Part 7.4.1 / IEC 60947-5-2,Part 7.4.2
POM

FCU1-D0601N-A3U0.2T/P8	1	
FCU1-D0601N-B3U0.2T/P8	2	
FCU1-D0601P-A3U0.2T/P8	3	
FCU1-D0601P-B3U0.2T/P8	4	
FCU1-D0601N-S4U0.2T/P8	6	
FCU1-D0601P-S4U0.2T/P8	5	
FCU1-D0601C-A2U0.2T/P8	7	FCU1-D061.5C-A2U0.2T/P8
FCU1-D0601C-B2U0.2T/P8	8	FCU1-D061.5C-B2U0.2T/P8
	1	ICU1-D061.5N-A3U0.2T/P8
	2	ICU1-D061.5N-B3U0.2T/P8
	3	ICU1-D061.5P-A3U0.2T/P8
	4	ICU1-D061.5P-B3U0.2T/P8
	6	ICU1-D061.5P-S4U0.2T/P8
	5	ICU1-D061.5N-S4U0.2T/P8

5-36v: ICU*-***** type switching
distance Sn=1.5mm.

3 φ 3x0.15	
Approx.38 g	Approx.39 g

φ 6.5	
●	●
1.0mm	1.5mm
stainless steel	
●	

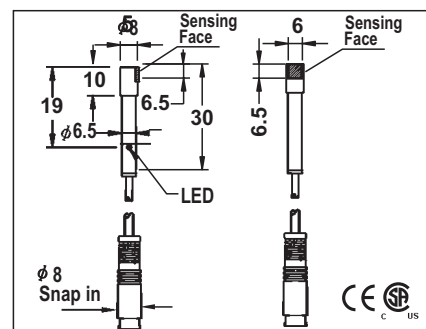

10-30VDC or 5-36VDC
<10%
<10mA
200mA
<0.01mA
-
-
<1.5V(10-30V) or <1.0V(5-36V)
2KHZ
0.1ms/0.1ms
<15%(Sr)
<1.0%(Sr)
IP67
-25°C - +70°C
<10%(Sr)
YES
220mA
<10ms
RFI>3V/m / EFT>1KV / ESD>4KV (contact)
IEC 60947-5-2,Part 7.4.1 / IEC 60947-5-2,Part 7.4.2
POM

FCU1-D0601N-A3U0.2T/SN8	1	
FCU1-D0601N-B3U0.2T/SN8	2	
FCU1-D0601P-A3U0.2T/SN8	3	
FCU1-D0601P-B3U0.2T/SN8	4	
FCU1-D0601N-S4U0.2T/SN8	6	
FCU1-D0601P-S4U0.2T/SN8	5	
FCU1-D0601C-A2U0.2T/SN8	7	FCU1-D061.5C-A2U0.2T/SN8
FCU1-D0601C-B2U0.2T/SN8	8	FCU1-D061.5C-B2U0.2T/SN8
	1	ICU1-D061.5N-A3U0.2T/SN8
	2	ICU1-D061.5N-B3U0.2T/SN8
	3	ICU1-D061.5P-A3U0.2T/SN8
	4	ICU1-D061.5P-B3U0.2T/SN8
	6	ICU1-D061.5P-S4U0.2T/SN8
	5	ICU1-D061.5N-S4U0.2T/SN8

5-36v: ICU*-***** type switching
distance Sn=1.5mm.

3 φ 3x0.15	
Approx.38 g	Approx.39 g

SIDE SENSING DC INDUCTIVE PROXIMITY SWITCH

φ 6.5	
●	●
1.0mm	1.5mm
stainless steel only	
●	

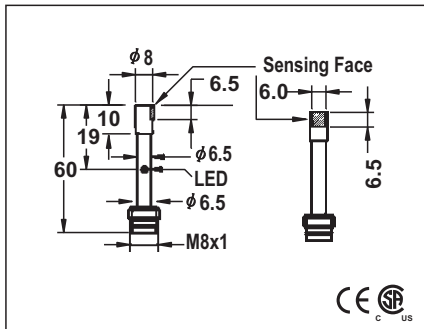

10-30VDC or 5-36VDC	
<10%	
<10mA	
200mA	
<0.01mA	
-	
-	
<1.5(10-30V) or <1.0V(5-36V)	
2KHZ	
0.1ms/0.1ms	
<15%(Sr)	
<1.0%(Sr)	
IP67	
-25 °C - +70 °C	
<10%(Sr)	
YES	
220mA	
<10ms	
RFI>3V/m / EFT>1KV / ESD>4KV (contact)	
IEC 60947-5-2,Part 7.4.1 / IEC 60947-5-2,Part 7.4.2	
POM	

FCU1-D061.0N-ACU3T	25	
FCU1-D061.0N-BCU3T	25	
FCU1-D061.0P-ACU3T	26	
FCU1-D061.0P-BCU3T	26	
FCU1-D061.0P-SCU4T	28	
FCU1-D061.0N-SCU4T	27	
FCU1-D061.0C-ACU3T	35	FCU1-D061.5C-ACU3T
FCU1-D061.0C-BCU3T	73	FCU1-D061.5C-BCU3T
	25	ICU1-D061.5N-ACU3T
	25	ICU1-D061.5N-BCU3T
	26	ICU1-D061.5P-ACU3T
	26	ICU1-D061.5P-BCU3T
	28	ICU1-D061.5P-SCU4T
	27	ICU1-D061.5N-SCU4T

5-36v: ICU*.*.*.*.* type switching
distance Sn=1.5mm.

Approx.15 g

φ 6.5	
●	●
1.0mm	1.5mm
stainless steel only	
●	

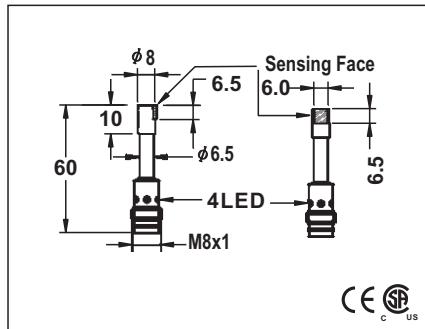

10-30VDC or 5-36VDC	
<10%	
<10mA	
200mA	
<0.01mA	
-	
-	
<1.5(10-30V) or <1.0V(5-36V)	
2KHZ	
0.1ms/0.1ms	
<15%(Sr)	
<1.0%(Sr)	
IP67	
-25 °C - +70 °C	
<10%(Sr)	
YES	
220mA	
<10ms	
RFI>3V/m / EFT>1KV / ESD>4KV (contact)	
IEC 60947-5-2,Part 7.4.1 / IEC 60947-5-2,Part 7.4.2	
POM	

FCU1-D061.0N-ARU3T	25	
FCU1-D061.0N-BRU3T	25	
FCU1-D061.0P-ARU3T	26	
FCU1-D061.0P-BRU3T	26	
FCU1-D061.0P-SRU4T	28	
FCU1-D061.0N-SRU4T	27	
FCU1-D061.0C-ARU3T	35	FCU1-D061.5C-ARU3T
FCU1-D061.0C-BRU3T	73	FCU1-D061.5C-BRU3T
	25	ICU1-D061.5N-ARU3T
	25	ICU1-D061.5N-BRU3T
	26	ICU1-D061.5P-ARU3T
	26	ICU1-D061.5P-BRU3T
	28	ICU1-D061.5P-SRU4T
	27	ICU1-D061.5N-SRU4T

5-36v: ICU*.*.*.*.* type switching
distance Sn=1.5mm.

Approx.28 g

M 8	
●	●
1.0mm	1.5mm
stainless steel	
●	

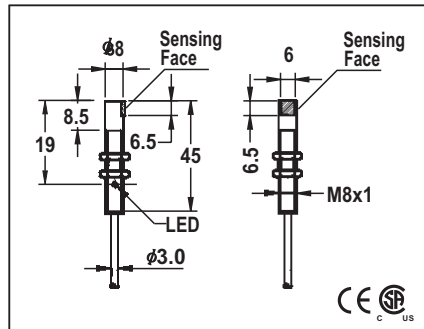

10-30VDC or 5-36VDC	
<10%	
<10mA	
200mA	
<0.01mA	
-	
-	
<1.5V(10-30V) or <1.0V(5-36V)	
2KHZ	
0.1ms/0.1ms	
<15%(Sr)	
<1.0%(Sr)	
IP67	
-25 °C - +70 °C	
<10%(Sr)	
YES	
220mA	
<10ms	
RFI>3V/m / EFT>1KV / ESD>4KV (contact)	
IEC 60947-5-2,Part 7.4.1 / IEC 60947-5-2,Part 7.4.2	
POM	

FCU1-0801N-A3U2T	1	
FCU1-0801N-B3U2T	2	
FCU1-0801P-A3U2T	3	
FCU1-0801P-B3U2T	4	
FCU1-0801P-S4U2T	6	
FCU1-0801N-S4U2T	5	
FCU1-0801C-A2U2T	7	FCU1-081.5C-A2U2T
FCU1-0801C-B2U2T	8	FCU1-081.5C-B2U2T
	21	FCM1-081.5NUT
	1	ICU1-081.5N-A3U2T
	2	ICU1-081.5N-B3U2T
	3	ICU1-081.5P-A3U2T
	4	ICU1-081.5P-B3U2T
	6	ICU1-081.5P-S4U2T
	5	ICU1-081.5N-S4U2T

5-36v: ICU*.*.*.*.* type switching
distance Sn=1.5mm.

3 φ 2x0.15
Approx.40 g

DC INDUCTIVE PROXIMITY SWITCH SQUARE TYPE

Q8
●
1.5 mm
die-cast
●

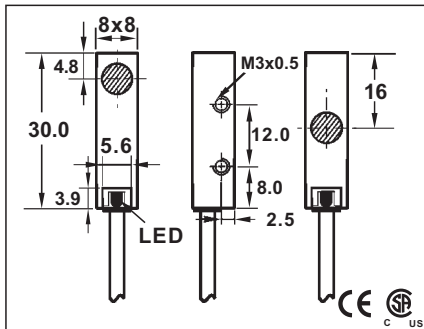

10-30VDC or 5-36VDC	
<10%	
<10mA	
200mA	
<0.01mA	
-	
-	
<1.5V	
2KHZ	
0.1ms/0.1ms	
<15%(Sr)	
<1.0%(Sr)	
IP67	
-25°C - +70°C	
<10%(Sr)	
YES	
220mA	
<10ms	

RFI>3V/m / EFT>1KV / ESD>4KV (contact)
IEC 60947-5-2,Part 7.4.1 / IEC 60947-5-2,Part 7.4.2

PBT

FQM1-881.5N-A3S2T	1	FQM1-881.5N-A3S2M
FQM1-881.5N-B3S2T	2	FQM1-881.5N-B3S2M
FQM1-881.5P-A3S2T	3	FQM1-881.5P-A3S2M
FQM1-881.5P-B3S2T	4	FQM1-881.5P-B3S2M

IQM1-881.5N-A3S2T	1	IQM1-881.5N-A3S2M
IQM1-881.5N-B3S2T	2	IQM1-881.5N-B3S2M
IQM1-881.5P-A3S2T	3	IQM1-881.5P-A3S2M
IQM1-881.5P-B3S2T	4	IQM1-881.5P-B3S2M

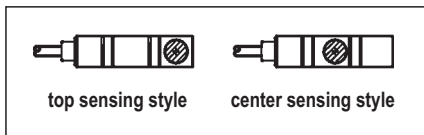

3.0 φ3X0.15
Approx.38 g

Q8
●
1.5 mm
die-cast
●

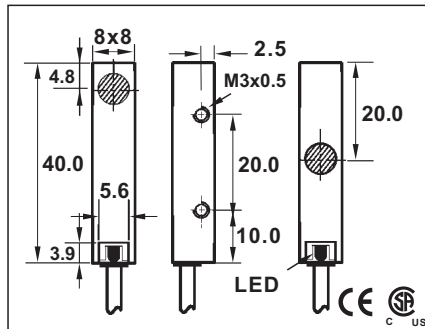

10-30VDC or 5-36VDC	
<10%	
<10mA	
200mA	
<0.01mA	
-	
-	
<1.5V	
2KHZ	
0.1ms/0.1ms	
<15%(Sr)	
<1.0%(Sr)	
IP67	
-25°C - +70°C	
<10%(Sr)	
YES	
220mA	
<10ms	

RFI>3V/m / EFT>1KV / ESD>4KV (contact)
IEC 60947-5-2,Part 7.4.1 / IEC 60947-5-2,Part 7.4.2

PBT

FQM1-881.5N-A3U2T	1	FQM1-881.5N-A3U2M
FQM1-881.5N-B3U2T	2	FQM1-881.5N-B3U2M
FQM1-881.5P-A3U2T	3	FQM1-881.5P-A3U2M
FQM1-881.5P-B3U2T	4	FQM1-881.5P-B3U2M

IQM1-881.5N-A3U2T	1	IQM1-881.5N-A3U2M
IQM1-881.5N-B3U2T	2	IQM1-881.5N-B3U2M
IQM1-881.5P-A3U2T	3	IQM1-881.5P-A3U2M
IQM1-881.5P-B3U2T	4	IQM1-881.5P-B3U2M

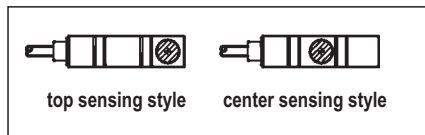

3.0 φ3X0.15
Approx.38 g

Q8
●
1.5 mm
die-cast
●

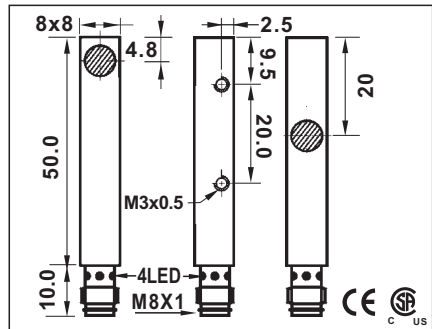

10-30VDC or 5-36VDC	
<10%	
<10mA	
200mA	
<0.01mA	
-	
-	
<1.5V	
2KHZ	
0.1ms/0.1ms	
<15%(Sr)	
<1.0%(Sr)	
IP67	
-25°C - +70°C	
<10%(Sr)	
YES	
220mA	
<10ms	

RFI>3V/m / EFT>1KV / ESD>4KV (contact)
IEC 60947-5-2,Part 7.4.1 / IEC 60947-5-2,Part 7.4.2

PBT

FQM1-881.5N-ACU3T	25	FQM1-881.5N-ACU3M
FQM1-881.5N-BCU3T	25	FQM1-881.5N-BCU3M
FQM1-881.5P-ACU3T	26	FQM1-881.5P-ACU3M
FQM1-881.5P-BCU3T	26	FQM1-881.5P-BCU3M

IQM1-881.5N-ACU3T	25	IQM1-881.5N-ACU3M
IQM1-881.5N-BCU3T	25	IQM1-881.5N-BCU3M
IQM1-881.5P-ACU3T	26	IQM1-881.5P-ACU3M
IQM1-881.5P-BCU3T	26	IQM1-881.5P-BCU3M

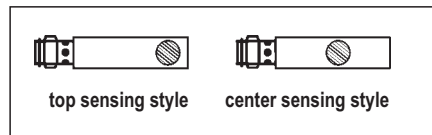

Approx.38 g

DC INDUCTIVE PROXIMITY SWITCH SQUARE TYPE

Q 12
●
2 mm
die-cast
●

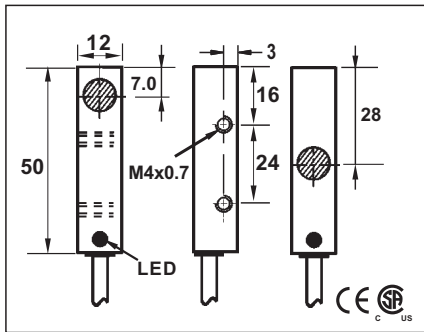

10-30VDC or 5-36VDC or 10-55VDC	
<10%	
<10mA	<20mA
200mA	
<0.01mA	
-	
-	
<1.5V or <1.0V or <2.0V	
2KHZ	
0.1ms/0.1ms	
<15%(Sr)	
<1.0%(Sr)	
IP67	
-25 °C - +70 °C	
<10%(Sr)	
YES	
220mA	
<10ms	
RFI>3V/m / EFT>1KV / ESD>4KV (contact)	
IEC 60947-5-2, Part 7.4.1 / IEC 60947-5-2, Part 7.4.2	
POM	

FQM1-1202N-A3U2T	1	FQM1-1202N-A3U2M
FQM1-1202N-B3U2T	2	FQM1-1202N-B3U2M
FQM1-1202P-A3U2T	3	FQM1-1202P-A3U2M
FQM1-1202P-B3U2T	4	FQM1-1202P-B3U2M
FQM1-1202P-S4U2T	6	FQM1-1202P-S4U2M
FQM1-1202N-S4U2T	5	FQM1-1202N-S4U2M
FQM1-1202C-A2U2T	7	FQM1-1202C-A2U2M
FQM1-1202C-B2U2T	8	FQM1-1202C-B2U2M
HQM1-1202N-A3U2T	1	HQM1-1202N-A3U2M
HQM1-1202N-B3U2T	2	HQM1-1202N-B3U2M
HQM1-1202P-A3U2T	3	HQM1-1202P-A3U2M
HQM1-1202P-B3U2T	4	HQM1-1202P-B3U2M
IQM1-1202N-A3U2T	1	IQM1-1202N-A3U2M
IQM1-1202N-B3U2T	2	IQM1-1202N-B3U2M
IQM1-1202P-A3U2T	3	IQM1-1202P-A3U2M
IQM1-1202P-B3U2T	4	IQM1-1202P-B3U2M
IQM1-1202P-S4U2T	6	IQM1-1202P-S4U2M
IQM1-1202N-S4U2T	5	IQM1-1202N-S4U2M

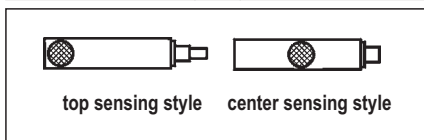

4 φ 3x0.15
Approx.75 g

Q 12
●
2 mm
die-cast
●

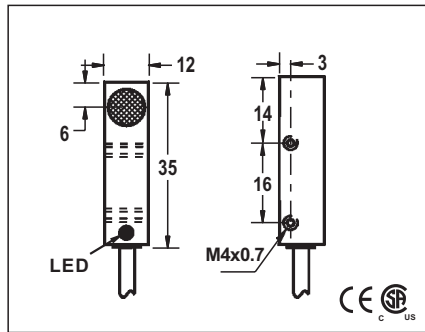

10-30VDC or 5-36VDC	
<10%	
<10mA	<20mA
200mA	
<0.01mA	
-	
-	
<1.5V(10-30V) or <1.0V(5-36V)	
2KHZ	
0.1ms/0.1ms	
<15%(Sr)	
<1.0%(Sr)	
IP67	
-25 °C - +70 °C	
<10%(Sr)	
YES	
220mA	
<10ms	
RFI>3V/m / EFT>1KV / ESD>4KV (contact)	
IEC 60947-5-2, Part 7.4.1 / IEC 60947-5-2, Part 7.4.2	
POM	

FQM1-1202N-A3S2T	1
FQM1-1202N-B3S2T	2
FQM1-1202P-A3S2T	3
FQM1-1202P-B3S2T	4
IQM1-1202N-A3S2T	1
IQM1-1202N-B3S2T	2
IQM1-1202P-A3S2T	3
IQM1-1202P-B3S2T	4
IQM1-1202P-S4S2T	6
IQM1-1202N-S4S2T	5



4 φ 3x0.15
Approx.70 g

Q 12
●
2 mm
die-cast
●

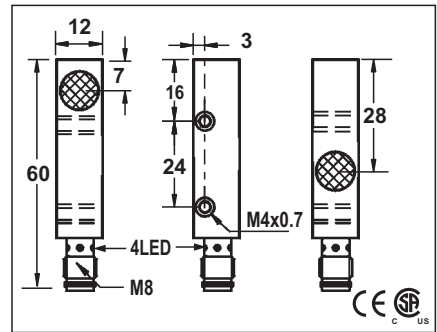

10-30VDC or 5-36VDC or 10-55VDC	
<10%	
<10mA	<20mA
200mA	
<0.01mA	
-	
-	
<1.5V or <1.0V or <2.0V	
2KHZ	
0.1ms/0.1ms	
<15%(Sr)	
<1.0%(Sr)	
IP67	
-25 °C - +70 °C	
<10%(Sr)	
YES	
220mA	
<10ms	
RFI>3V/m / EFT>1KV / ESD>4KV (contact)	
IEC 60947-5-2, Part 7.4.1 / IEC 60947-5-2, Part 7.4.2	
POM	

FQM1-1202N-ACU3T	25	FQM1-1202N-ACU3M
FQM1-1202N-BCU3T	25	FQM1-1202N-BCU3M
FQM1-1202P-ACU3T	26	FQM1-1202P-ACU3M
FQM1-1202P-BCU3T	26	FQM1-1202P-BCU3M
FQM1-1202P-SCU4T	28	FQM1-1202P-SCU4M
FQM1-1202N-SCU4T	27	FQM1-1202N-SCU4M
FQM1-1202C-ACU3T	35	FQM1-1202C-ACU3M
FQM1-1202C-BCU3T	73	FQM1-1202C-BCU3M
HQM1-1202N-ACU3T	25	HQM1-1202N-ACU3M
HQM1-1202N-BCU3T	25	HQM1-1202N-BCU3M
HQM1-1202P-ACU3T	26	HQM1-1202P-ACU3M
HQM1-1202P-BCU3T	26	HQM1-1202P-BCU3M
IQM1-1202N-ACU3T	25	IQM1-1202N-ACU3M
IQM1-1202N-BCU3T	25	IQM1-1202N-BCU3M
IQM1-1202P-ACU3T	26	IQM1-1202P-ACU3M
IQM1-1202P-BCU3T	26	IQM1-1202P-BCU3M
IQM1-1202P-SCU4T	28	IQM1-1202P-SCU4M
IQM1-1202N-SCU4T	27	IQM1-1202N-SCU4M

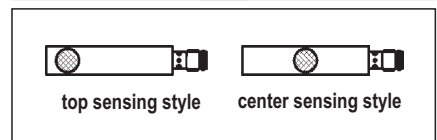

Approx.38 g
