

SELECTION GUIDE

● For Amplifier unit

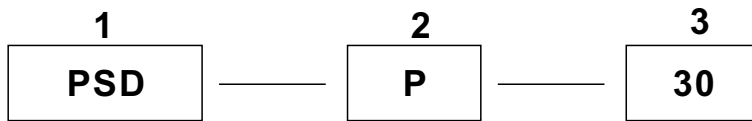





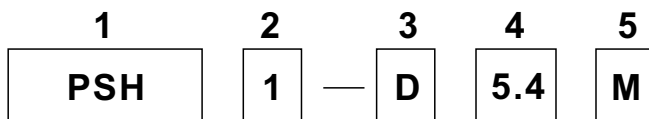







1. Proximity Separate Amplifier
2. P=PNP, N=NPN, A=AC
3. 30=10~30VDC, 250=20~250VAC

● For Sensing head unit







1. Proximity Separate Amplifier Sensing head
 2. 1=Shielded, 2=NON-Shielded
 3. D=smooth body, M=Screw thread body
 4. 5.4=Diameter of tube
 5. M=smooth or thread body with screw thread tube.
- =Smooth or thread body No with screw thread tube

LONG-DISTANCE, SEPARATE-AMPLIFIER PROXIMITY SENSORS

	<h2>PS series</h2>  	<h2>LONG-DISTANCE, SEPARATE-AMPLIFIER PROXIMITY SENSORS</h2> <p>A detecting distance twice that of conventional proximity sensors Wide range of types available.</p>				
						
						
						
						
						

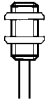
FEATURES

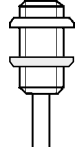
<p>Long detecting distance Separating the electronic circuit from the sensor head has increased the detecting distance of the PSC series proximity sensor to twice that of the built-in amplifier type proximity sensor.</p> <p>Alarm output The alarm output indicates a break in the sensor cable minimizing production line down time,</p> <p>17 models of sensor heads available Sensor heads are available in sizes ranging from 2.8 mm to 90.0 mm in diameter.</p> <p>Environment-proof Every sensor head conforms to IEC standard IP-67.</p>	Protected cable(PSH1-D5.4M/PSH1-D8.0M/PSH1-M10M) The sensor cable is encased in a stainless steel spiral tube to prevent breakage from excessive bending or metal swarf generated by machining tools.	
	Compact size, long detecting distance(PSH2-D2.80) The smallest PSC series proximity sensor, with a sensor head 2.8mm in diameter, offers the maximum detecting distance of 7mm.	
	Oil-resistant (PSH1-M8.0) Precision-machined stainless steel, and a special sealing mechanism makes the PSH1-M8.0 highly resistant to oil.	
	Space-saving(PSH1-T4.8) The PSC series thin-type sensor is only 4.8 mm thick, enabling it to be installed in areas of limited space.	
	Resistant to welding spatter(options!) The Teflon cap protects the sensor head(PSH1-D8.0 /PSH1-M10/PSH1-M14)from welding spatters.	

SELECTION CHART

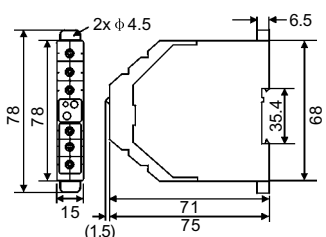

Amplifier Unit

Shape	Power Supply	Output	Function	Model
	10V~30V DC	NPN open collector 200mA	N.O./N.C.Choice	PSA-N-30
	10V~30V DC	PNP open collector 200mA	N.O./N.C. Choice	PSA-P-30
	20V~250VAC	MOSFET output 5-300mA	N.O./N.C.Choice	PSA-A-250

Amplifier unit



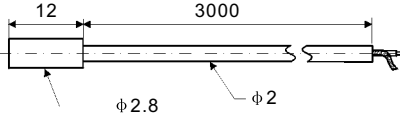
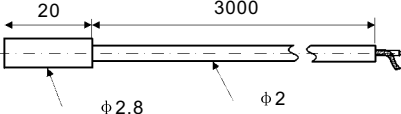

Kind	DC	AC
Mode	PSA-P-30 / PSA-N-30	PSA-A-250
Power supply	10~30VDC, Ripple (p-p): 10% max	20~250VDC
Current/Power consumption	18mA max	1VA max.
Response Time	1msmax	1VA max.
Temperature consumption	±8% of detecting distance at +23 °C(0 to +50 °C)	
Sensibility Adjustor	By15 turns trimmer	
Operation mode	N.C./N.O. (Witch selectable)	
Indicator	Output: red LED	
Control output	NPN or PNP open-collector :200MA(40V) max.	
Cable breakage alarm output	NPN or PNP open-collector :100MA(40V) max.	—
Leakage Current(OFF time)	—	0.2mA max.
Operating temperature	0~50 °C	
Weight	Approx. 48g	Approx. 125g

Sensor Head



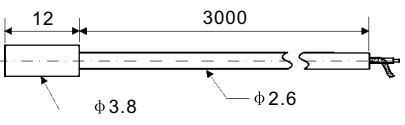
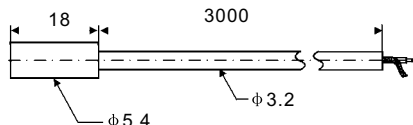
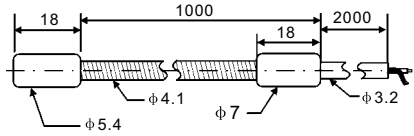

Diameter: mm	φ 2.8	φ 2.8
● Shielded ○ non-Shielded	●	○
Stable detecting range mm	0~0.6 mm	0~3 mm
Maximum detecting distance mm	1.2 mm	7 mm
Dimensions (unit: mm)		
Mode	Column	Column
Detected object	Ferrous metals(see Characteristics for non-ferrous metals)	Ferrous metals(see Characteristics for non-ferrous metals)
Standard target(iron,t=1mm)	5x5mm	5x5mm
Repeatability	0.002mm	0.002mm
Hysteresis	0.04mm	0.04mm
Temperature fluctuation	±10% max.of detecting distance at +23 °C(-10 to 60 °C)	±10% max.of detecting distance at +23 °C(-10 to 60 °C)
Degree of protection	IP-67	IP-67
Operating humidity	-10~+60 °C	-10~+60 °C
Part number	PSH1-D2.8	PSH2-D2.8
Form		
Weight(include screw NVT& 3m Cable)	Approx.29g	Approx.31g

SEPARATE-AMPLIFIER PROXIMITY SENSORS

Sensor Head

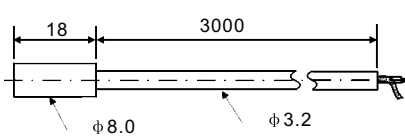
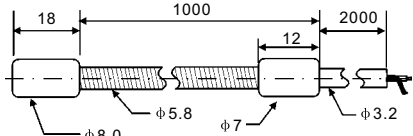
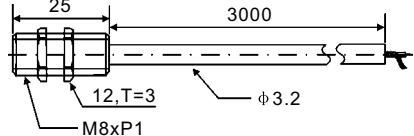
$\phi 3.8$	$\phi 5.4$	$\phi 5.4$
●	●	●
0~0.8 mm	0~1 mm	0~1 mm
2 mm	3 mm	3 mm
		
Column	Column	Column with screw tube
Ferrous metals(see Characteristics for non-ferrous metals)	Ferrous metals(see Characteristics for non-ferrous metals)	Ferrous metals(see Characteristics for non-ferrous metals)
5x5mm	5x5mm	5x5mm
0.002mm	0.002mm	0.002mm
0.05mm	0.05mm	0.05mm
±10% max.of detecting distance at +23℃(-10 to 60℃)	±10% max.of detecting distance at +23℃(-10 to 60℃)	±10% max.of detecting distance at +23℃(-10 to 60℃)
IP-67	IP-67	IP-67
-10~+60℃	-10~+60℃	-10~+60℃
PSH1-D3.8	PSH1-D5.4	PSH1-D5.4M
		
Approx.38g	Approx.60g	Approx.76g

Sensor Head

$\phi 8.0$	$\phi 8.0$	M8
●	●	●
0~2 mm	0~2 mm	0~1.5 mm
5 mm	5 mm	2.5 mm
		
Column	Column with screw tube	Column nut mode, oil resistant
Ferrous metals(see Characteristics for non-ferrous metals)	Ferrous metals(see Characteristics for non-ferrous metals)	Ferrous metals(see Characteristics for non-ferrous metals)
5x5mm	5x5mm	10x10mm
0.005mm	0.005mm	0.005mm
0.04mm	0.04mm	0.07mm
±10% max.of detecting distance at +23℃(-10 to 60℃)	±10% max.of detecting distance at +23℃(-10 to 60℃)	±10% max.of detecting distance at +23℃(-10 to 60℃)
IP-67	IP-67	IP-67
-10~+60℃	-10~+60℃	-10~+60℃
PSH1-D8.0	PSH1-D8.0M	PSH1-M8.0
		
Approx.51g	Approx.88g	Approx.51g

SPEARATE-AMPLIFIER PROXIMITY SENSORS

Sensor Head

M10	M10	M14
●	●	●
0~2mm	0~2 mm	0~5 mm
5 mm	5 mm	8 mm
Screw nut mode	Screw nut mode, oil resistant	Screw nut mode
Ferrous metals(see Characteristics for non-ferrous metals)	Ferrous metals(see Characteristics for non-ferrous metals)	Ferrous metals(see Characteristics for non-ferrous metals)
10x10mm	10x10mm	15x15mm
0.005mm	0.005mm	0.005mm
0.04mm	0.04mm	0.05mm
±10% max.of detecting distance at +23℃(-10 to 60℃)	±10% max.of detecting distance at +23℃(-10 to 60℃)	±10% max.of detecting distance at +23℃(-10 to 60℃)
IP-67	IP-67	IP-67
-10~+60℃	-10~+60℃	-10~+60℃
PSH1-M10	PSH1-M10M	PSH1-M14
Approx.55g	Approx.100g	Approx.62g

Sensor Head

φ 14.5	φ 22	φ 30
○	○	○
0~6 mm	0~9 mm	0~12 mm
13 mm	18 mm	25 mm
Screw nut mode	Screw nut mode	Screw nut mode
Ferrous metals(see Characteristics for non-ferrous metals)	Ferrous metals(see Characteristics for non-ferrous metals)	Ferrous metals(see Characteristics for non-ferrous metals)
20x20mm	25x25mm	30x30mm
0.012mm	0.02mm	0.025mm
0.05mm	0.06mm	0.08mm
±10% max.of detecting distance at +23℃(-10 to 60℃)	±10% max.of detecting distance at +23℃(-10 to 60℃)	±10% max.of detecting distance at +23℃(-10 to 60℃)
IP-67	IP-67	IP-67
-10~+60℃	-10~+60℃	-10~+60℃
PSH2-M14.5	PSH2-M22	PSH2-M30
Approx.72g	Approx.31g	Approx.225g

SEPARATE-AMPLIFIER PROXIMITY SENSORS

Sensor Head

$\phi 40$	T=4.8	$\phi 90$
0~18 mm	0~5 mm	0~35 mm
36 mm	8 mm	70 mm
Screw nut mode	Slim	Column
Ferrous metals(see Characteristics for non-ferrous metals)	Ferrous metals(see Characteristics for non-ferrous metals)	Ferrous metals(see Characteristics for non-ferrous metals)
40x40mm	15x15mm	150x150 mm
0.037mm	0.005mm	0.075mm
0.15mm	0.05mm	0.2mm
$\pm 10\%$ max.of detecting distance at +23°C(-10 to 60 °C)	$\pm 10\%$ max.of detecting distance at +23°C(-10 to 60 °C)	$\pm 10\%$ max.of detecting distance at +23°C(-10 to 60 °C)
IP-67	IP-67	IP-67
-10~+60 °C	-10~+60 °C	-10~+60 °C
PSH2-M40	PSH1-T4.8	PSH2-T90
Approx.280g	Approx.59g	Approx.650g

CONNECTION

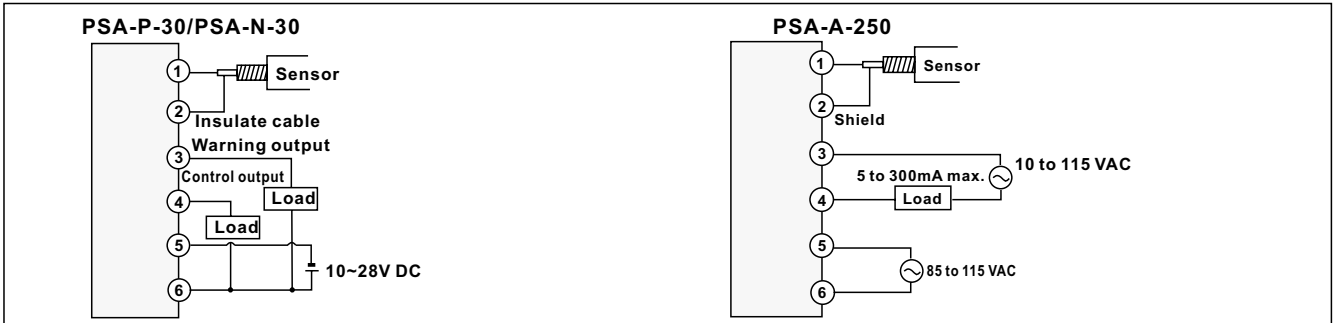

OUTPUT CIRCUIT

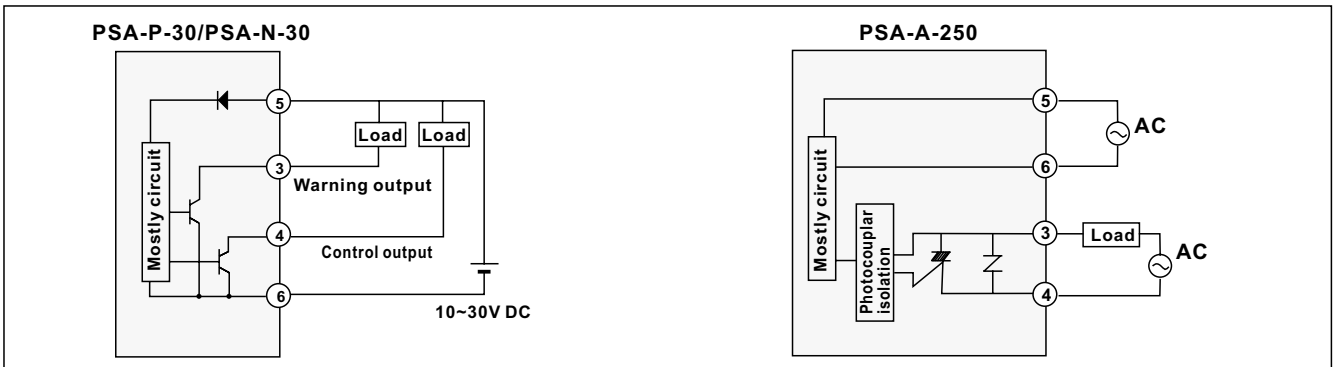

OPERATION MODE SELECTOR SWITCH

A: NEAR-ON operation mode(N.O.)

B: NEAR-OFF operation mode(N.C.)

Use a screwdriver to set the position of the operation mode selector switch, located in the lower part the controller, to the desired operation mode.

SEPARATE-AMPLIFIER PROXIMITY SENSORS

TIMING CHART

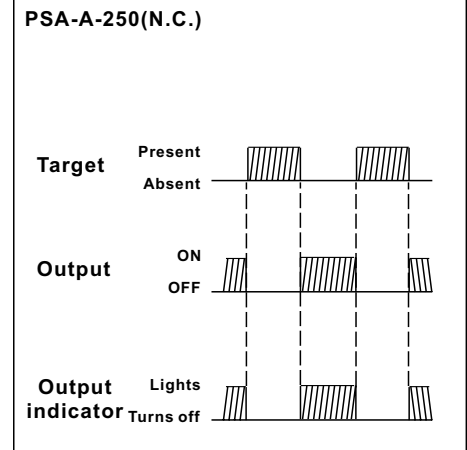
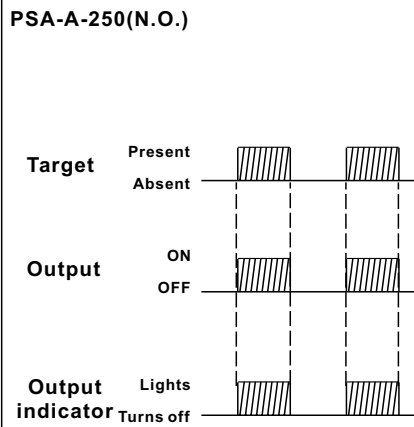
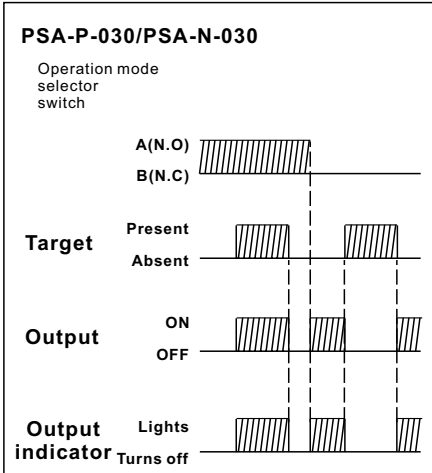

CHARACTERISTICS

Detection range (Typical)

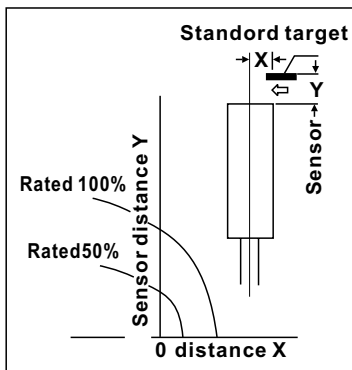

Parallel Deviation curve About different distance

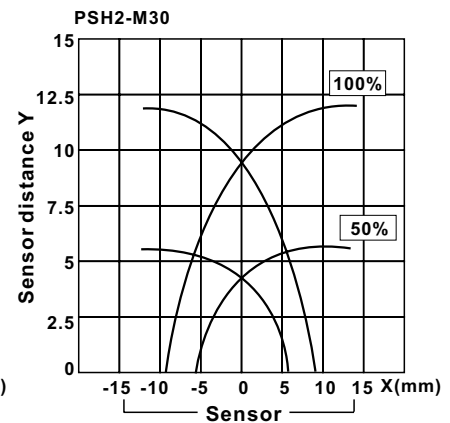
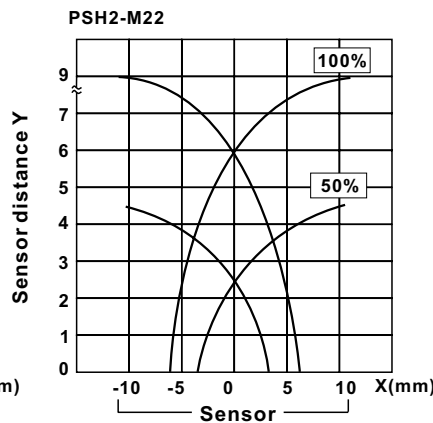
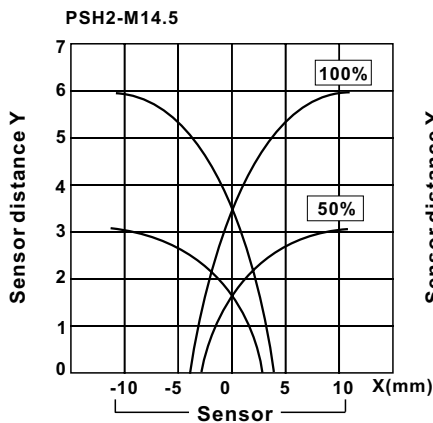
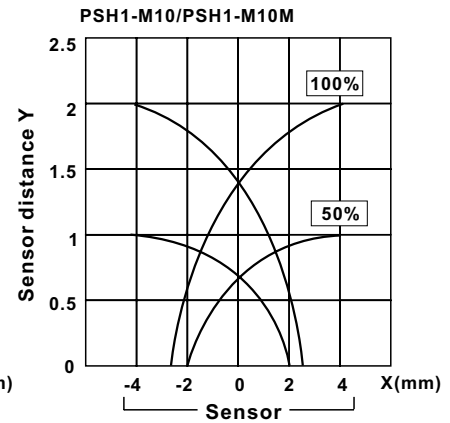
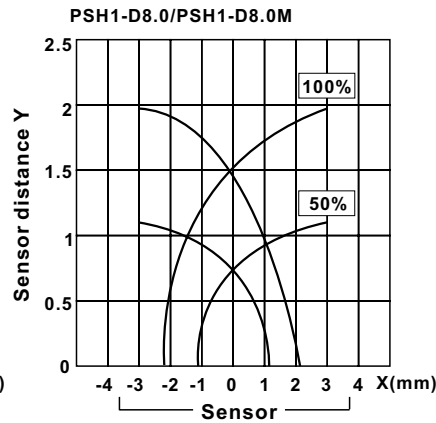
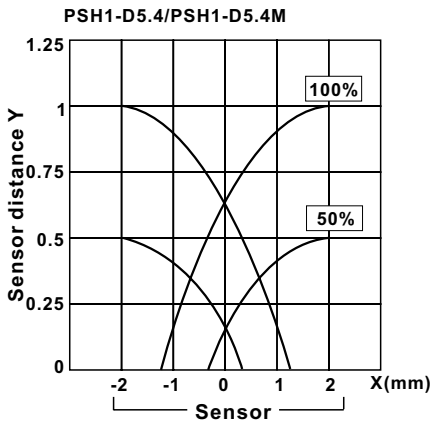
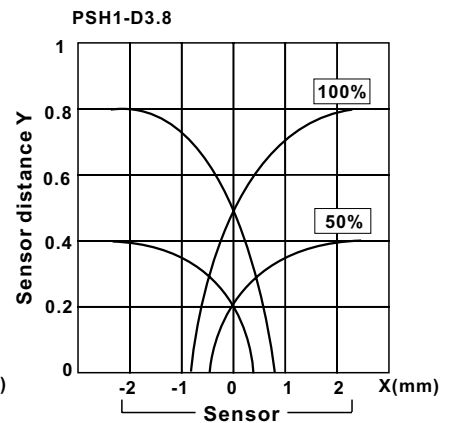
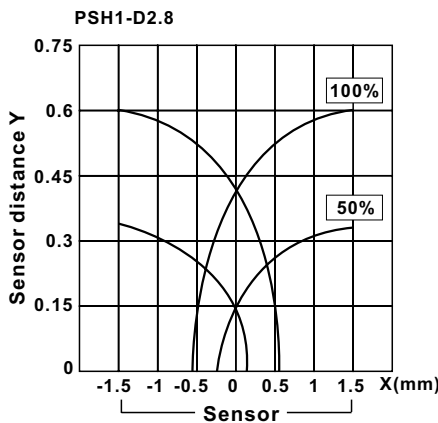

SEPARATE-AMPLIFIER PROXIMITY SENSORS

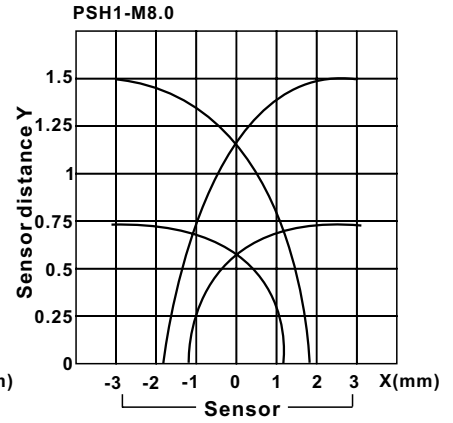
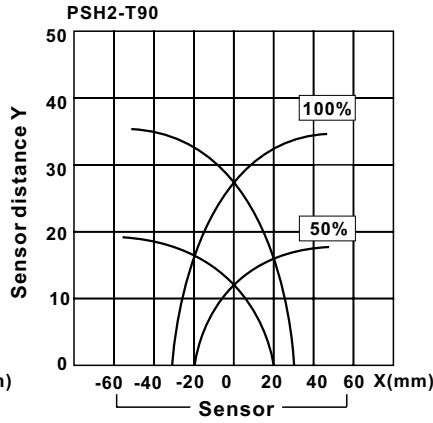
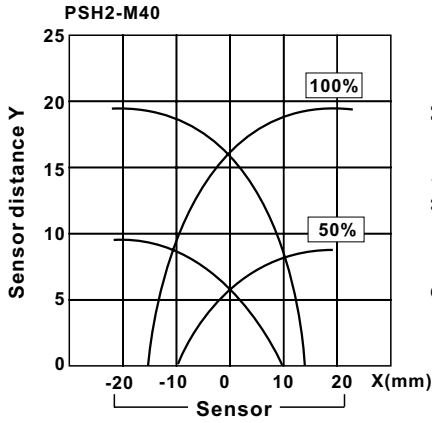

Sensing Range at different Sensing Object Size & Material

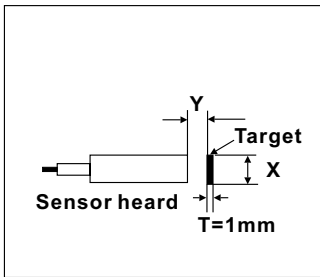

All these curves plotting at the following conditions:
 1. the sensitivities has been set such that a standard target is detected at a rated distance
 2. Obtained the sensing distance (Ymm) variable by changed the size(XxXx1mm) of the cube metal

PSH1-D2.8 Adjusted the sensing distance 0.6mm with 20mm meta boardl

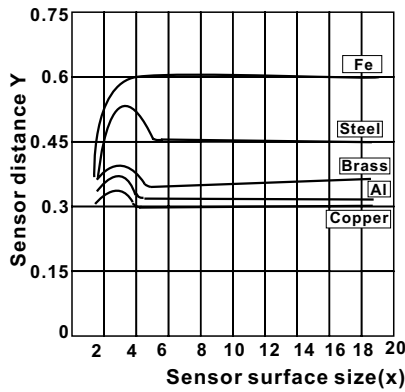

PSH1-D3.8 Adjusted the sensing distance 0.8mm with 20mm meta boardl

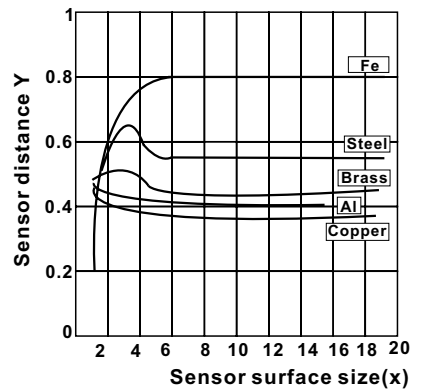

PSH1-D5.4 Adjusted the sensing distance 1mm with 20mm meta boardl

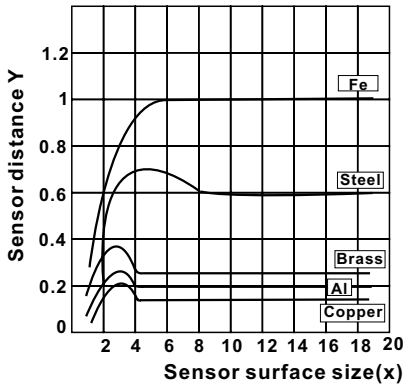

PSH1-D8.0 Adjusted the sensing distance 2mm with 20mm meta boardl

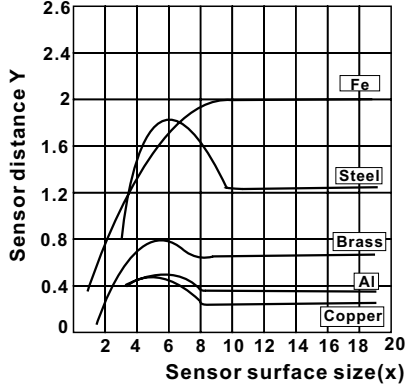

PSH1-M10 Adjusted the sensing distance 2mm with 20mm meta boardl

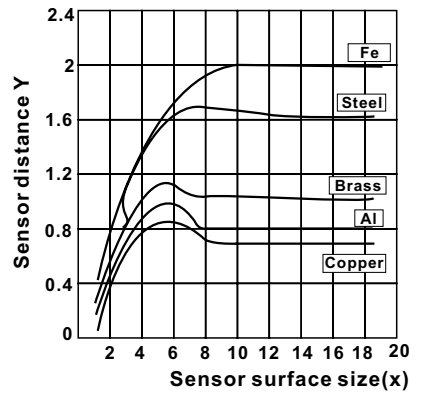

PSH1-M14 Adjusted the sensing distance 5mm with 40mm meta boardl

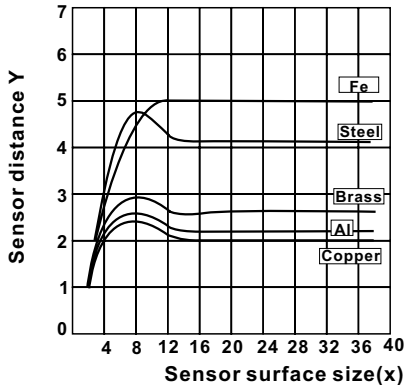

PSH1-T4.8 Adjusted the sensing distance 5mm with 40mm meta boardl

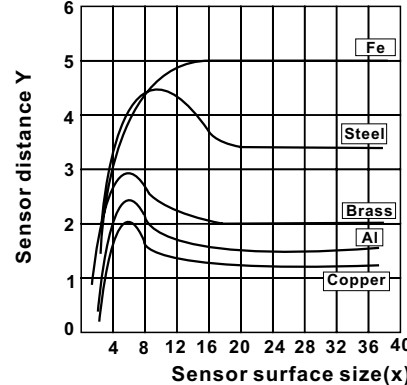

PSH2-D2.8 Adjusted the sensing distance 3mm with 20mm meta boardl

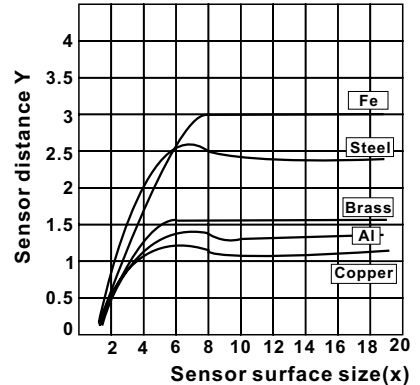

SEPARATE-AMPLIFIER PROXIMITY SENSORS

CHARACTERISTICS

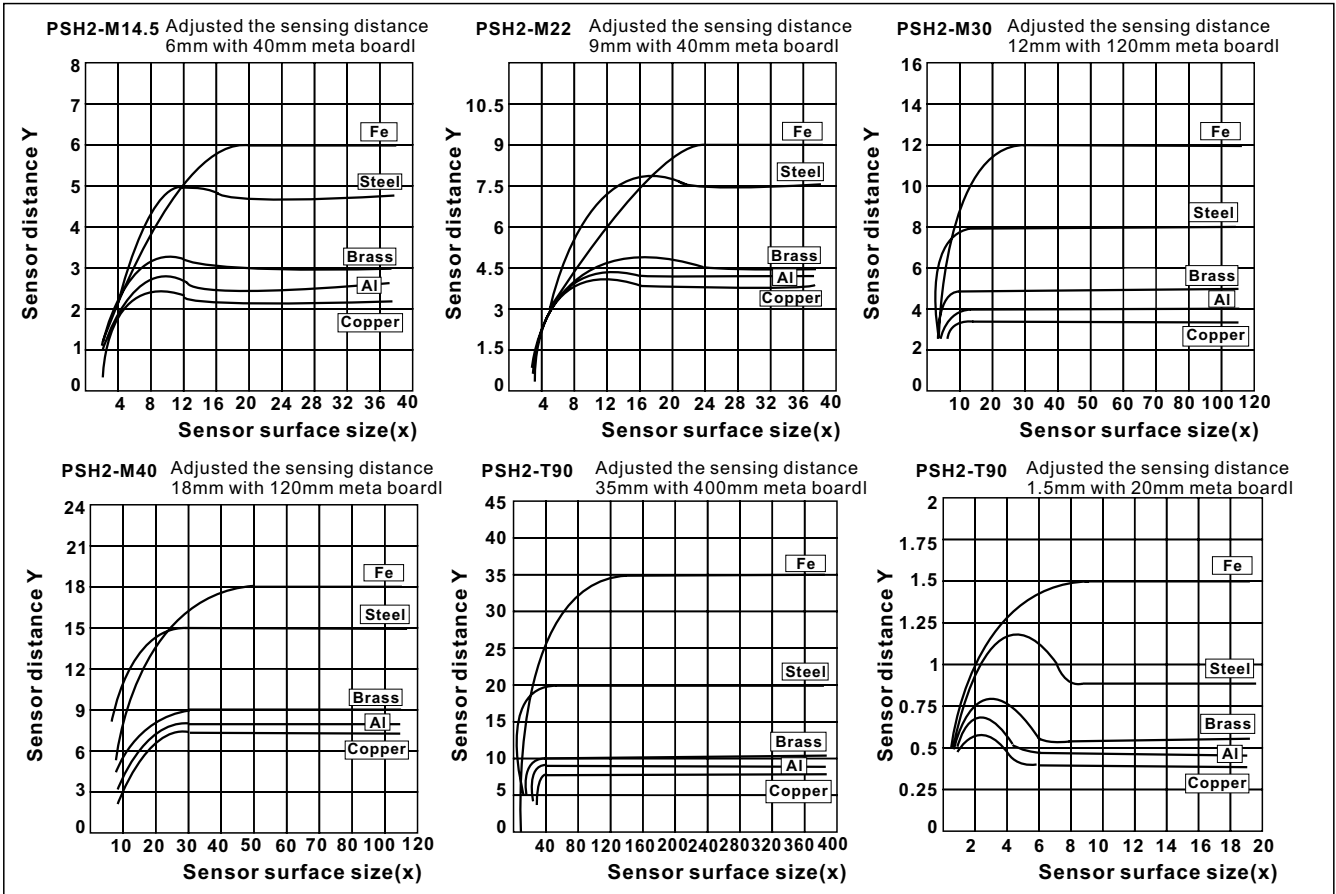

HINTS ON CORRECT USE

Mounting

- ★ Cylindrical type
Secure the sensor head with a screw at a position 5mm or more from the tip of the head.
(Tightening torque: 2 kgf-cm max)

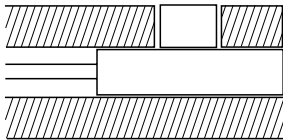

- ★ Threaded type
When mounting the threaded-type sensor head, do not tighten beyond the torque specified in the following table.

Model	Tightening torque
PSH1-M8	80 kgf-cm max
PSH1-M10	100 kgf-cm max
PSH1-M14	200 kgf-cm max
PSH2-M14.5	
PSH2-M22	100 kgf-cm max
PSH2-M30	
PSH2-M40	

Wiring

- ★ Use a high-frequency coaxial cable to connect the sensor head to the amplifier unit. Limit the length of extension to within 10m (5m for models PSH1-D2.8 and PSH2-D2.8)

Surrounding metal

Shielded-type sensors can be flush-mounted in a metal base. Sensors of the non-shielded type, however, should be mounted according to the guidelines given below in order to minimize interference from the surrounding metal.

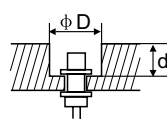

Model	D(mm min)	d(mm min)
PSH1-D2.8	20	15
PSH2-M14.5	30	10
PSH2-M22	45	20
PSH2-M30	70	25
PSH2-M40	100	30
PSH2-T90	260	30

Surrounding metal

When installing 2 to more sensors of the same model face-to-face or in parallel, separate by the distance specified in the following table to prevent interference

Model	Distance	
	Face-to-face(mm min)	Parallel(mm min)
PSH1-D2.8	2(1)	NO space required
PSH1-D3.8	2(1)	NO space required
PSH1-D5.4M	5(3)	NO space required
PSH1-D8.0M	10(7)	NO space required
PSH1-M10M	7(4)	35 (no space required)
PSH1-M14	11(6)	39 (no space required)
PSH1-T4.8	11(6)	64 (no space required)
PSH2-D2.8	53(12)	23 (11)
PSH2-M14.5	11(7)	115 (no space required)
PSH2-M22	26(9)	122 (no space required)
PSH2-M30	41(14)	250 (no space required)
PSH2-M40	38(29)	300 (no space required)
PSH1-M8.0	7(4)	NO space required

Note: the above figures apply when the trimmer is turned to its optimal position for stable detection. The figures in parentheses apply when an optional interference prevention adapter is connected parallel to the sensor head, contact scan for further information.